

Infrared Receiver Module IRM-V8xxM3/TR1 Series



Pin Configuration

1. GND
2. VCC
3. OUT
4. GND

Block Diagram

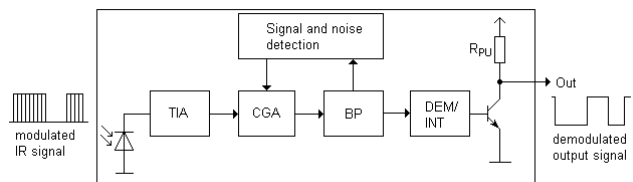

Features

- High protection ability against EMI.
- Circular lens for improved reception characteristics.
- Available for various carrier frequencies.
- min burst length (36/38 kHz): 8 cycles
- min burst length (56 kHz): 10 cycles
- min gap length (36/38 kHz): 12 cycles
- min gap length (56 kHz): 14 cycles
- Low operating voltage and low power consumption.
- High immunity against ambient light.
- High immunity against TFT and PDP backlight.
- Long reception range.
- High sensitivity.
- Pb free and RoHS compliant.
- Compliance with EU REACH.
- Compliance Halogen Free (Br <900 ppm, Cl <900 ppm, Br+Cl < 1500 ppm).

Description

The device is miniature SMD type infrared receiver that has been developed and designed by utilizing the latest IC technology.

The PIN diode and preamplifier are assembled onto a lead frame and molded into a black epoxy package which operates as an IR filter.

The demodulated output signal can directly be decoded by a microprocessor.

Applications

- AV equipment such as TV, VCR, DVD, CD, MD, etc.
- CATV set top boxes
- Multi-media Equipment
- Other devices using IR remote control

Application Circuit

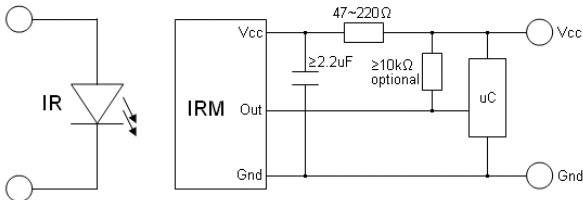

Parts Table

Model No.	Carrier Frequency
IRM-V836M3/TR1	36 kHz
IRM-V838M3/TR1	38 kHz
IRM-V856M3/TR1	56 kHz

Absolute Maximum Ratings (Ta=25°C)

Parameter	Symbol	Rating	Unit
Supply Voltage	Vcc	6	V
Operating Temperature	Topr	-20 ~ +85	°C
Storage Temperature	Tstg	-40 ~ +85	°C
Soldering Temperature *1	Tsol	260	°C

*1 Soldering time ≤ 5 seconds

Electro-Optical Characteristics (Ta=25°C)

Parameter	Symbol	Min.	Typ.	Max.	Unit	Condition
Current consumption	Icc	---	0.4	0.6	mA	No input signal
Supply voltage	V _{CC}	2.7	-	5.5	V	
Peak wavelength	λ _p	---	940	---	nm	
Reception range	L ₀	8	---	---	m	See chapter 'Test method'
	L ₄₅	5	---	---		
Half angle(horizontal)	φ _h	---	±45	---	deg	
Half angle(vertical)	φ _v	---	±45	---	deg	
High level pulse width	T _H	450	---	750	μs	Test signal according to figure 1
Low level pulse width	T _L	450	---	750	μs	
High level output voltage	V _{OH}	V _{CC} -0.4	---	---	V	
Low level output voltage	V _{OL}	---	0.2	0.5	V	I _{SINK} ≤ 2mA
Internal pull up resistor	R _{PU}	---	40	---	kΩ	

Test method

The specified electro-optical characteristics are valid under the following conditions.

1. Measurement environment

A place without extreme light reflections.

2. External light

The environment contains an ordinary, white fluorescent lamp without high frequency modulation. The color temperature is 2856K and the illumination at the IR receiver is less than 10 Lux ($E_v \leq 10\text{Lux}$).

3. Standard transmitter

The test transmitter is calibrated by using the circuit shown in figure 2. The radiation intensity of the transmitter is adjusted until $V_o=400\text{mVp-p}$. Both, the test transmitter and the photo diode, have a peak wavelength of 940nm. The photo diode for calibration is PD438B ($\lambda_p=940\text{nm}$, $V_r=5\text{V}$).

4. The measurement system is shown in Fig.-3

Fig.-1 Transmitter Wave Form

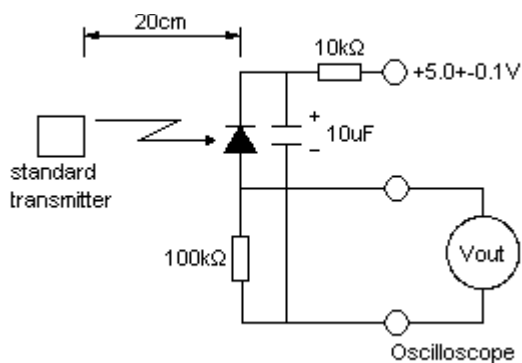
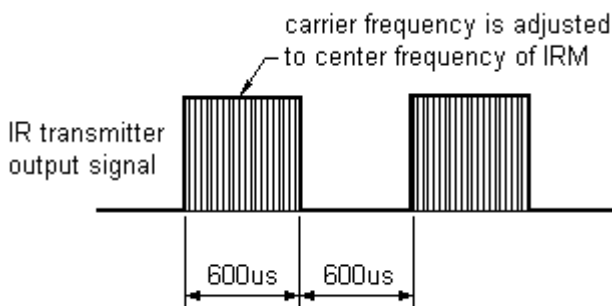

D.U.T output Pulse

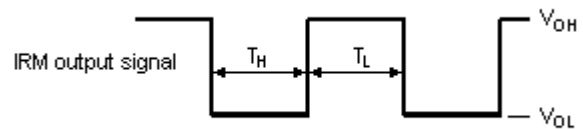
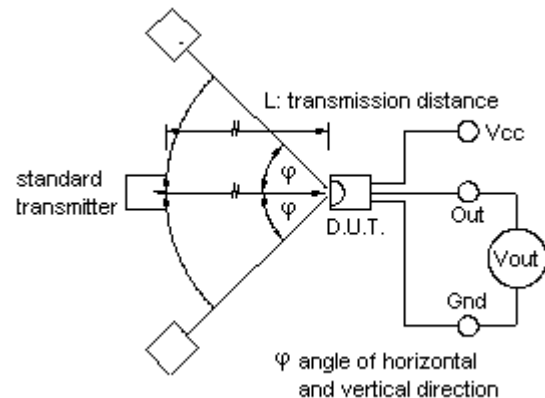

Fig.-3 Measuring System



Typical Electro-Optical Characteristics Curves

Fig.4 Relative Responsibility vs. Wavelength

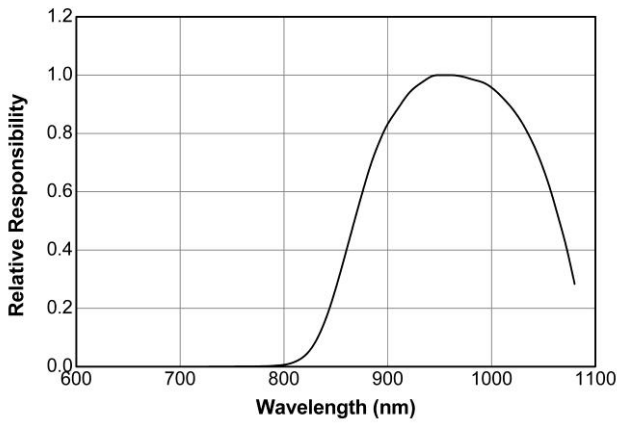

Fig.-5 Relative Sensitivity vs. Angle

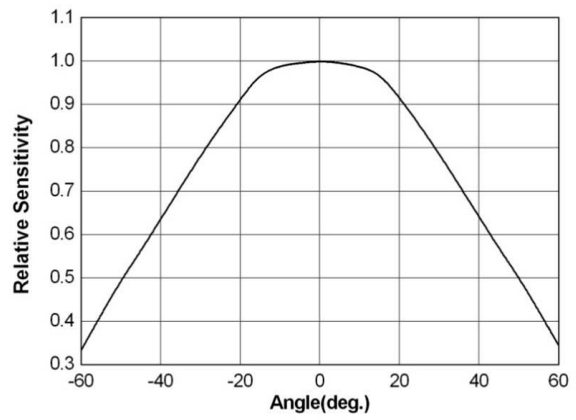

Fig.6 Variation Output Pulse Width vs. Distance

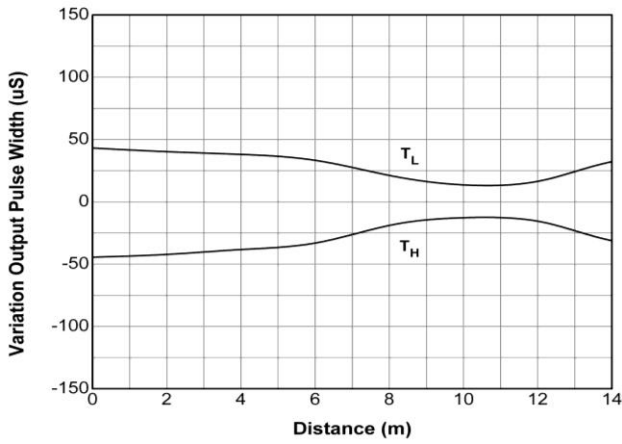

Fig.7 Relative Sensitivity vs. Supply Voltage

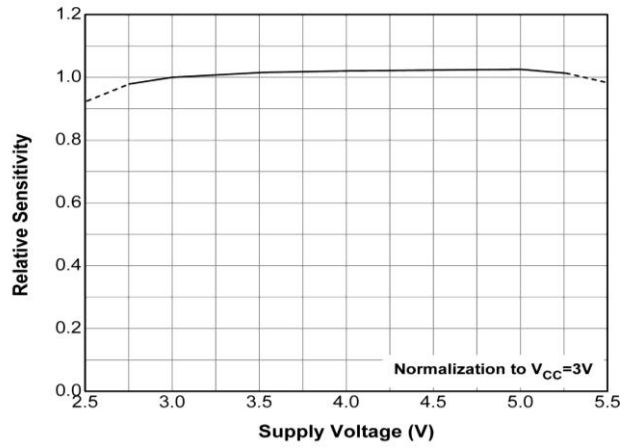
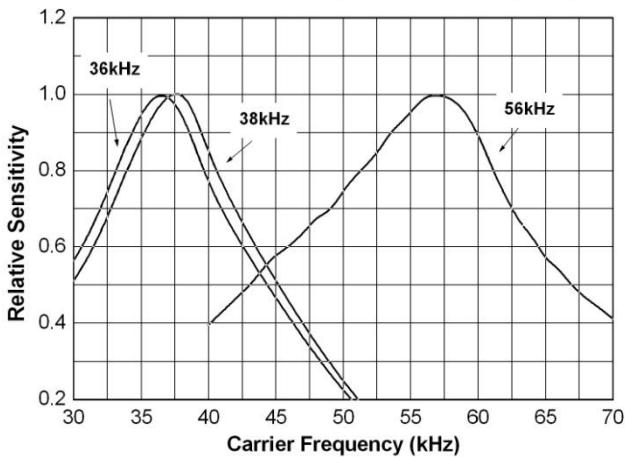
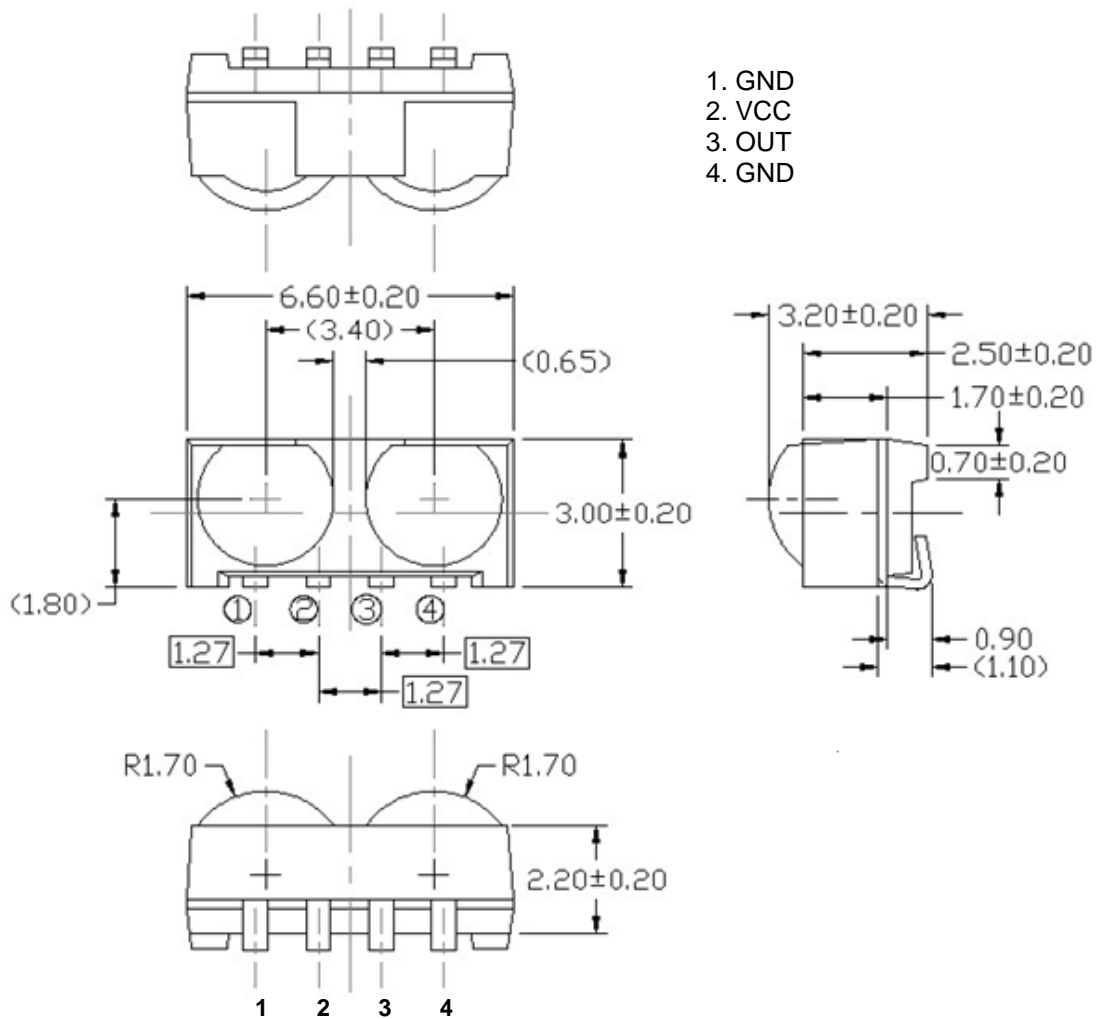

Fig.8 Relative Sensitivity vs. Carrier Frequency



Package Dimension
(Dimensions in mm)



Note: Tolerances unless mentioned $\pm 0.2\text{mm}$. Unit: mm

Recommended pad layout for surface mount leadform

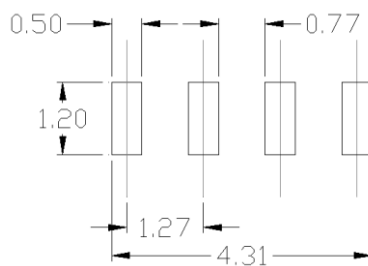

Notice: Suggested pad dimension is just for reference only.
Please modify the pad dimension based on individual need.

Code information

Protocol	Suitable	Protocol	Suitable
JVC	Yes	RCA	No
Matsushita	Yes	r-step ²⁾	Yes
Mitsubishi	No	Sharp	Yes
NEC	Yes	Sony 12 bit ³⁾	Yes
Panasonic	Yes	Sony 15 bit	No
RC5	Yes	Sony 20 bit	No
RC6 ¹⁾	Yes	Toshiba	Yes
RCMM	No	XMP-1	Yes
RCS-80	No	Continuous Code	No

1) Best choice depends on RC6 mode. If data low time is below 22ms, M2 is the best choice, otherwise M3.

2) For r-step 38kHz version M3 is the best choice, for 56kHz version only M is recommended.

3) If only Sony 12 bit version is used, M3 is recommended otherwise M2 is the best choice.

Tape & Reel Packing Specifications

(Dimensions in mm)

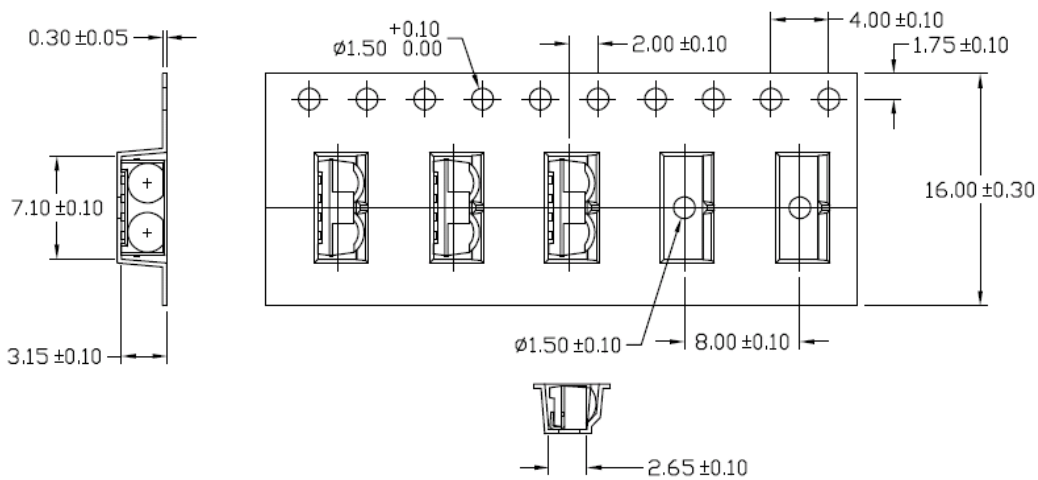

Packing Quantity

2000 pcs / Box
5 Boxes / Carton

Application Restrictions

1. Above specification may be changed without notice. EVERLIGHT will reserve authority on material change for above specification.
2. The graphs shown in this datasheet are representing typical data only and do not show guaranteed values.
3. When using this product, please observe the absolute maximum ratings and the instructions for use outlined in these specification sheets. EVERLIGHT assumes no responsibility for any damage resulting from use of the product which does not comply with the absolute maximum ratings and the instructions included in these specification sheets.
4. These specification sheets include materials protected under copyright of EVERLIGHT. Reproduction in any form is prohibited without the specific consent of EVERLIGHT.
5. This product is not intended to be used for military, aircraft, automotive, medical, life sustaining or life saving applications or any other application which can result in human injury or death. Please contact authorized Everlight sales agent for special application request.