

### GPIO Header

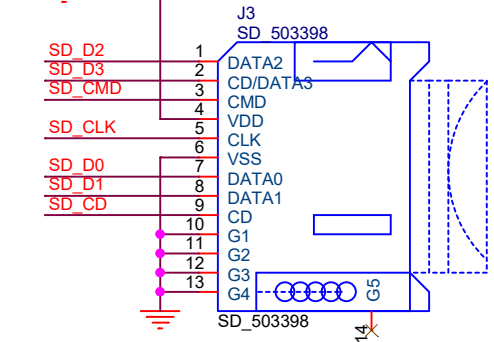

### Mouting Holes

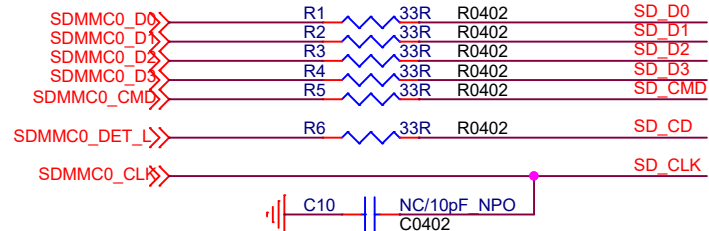
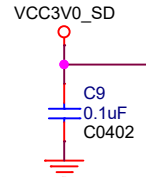
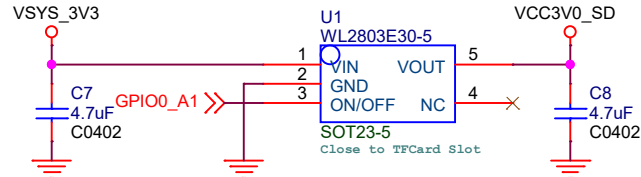
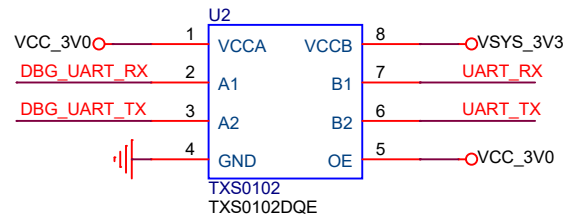
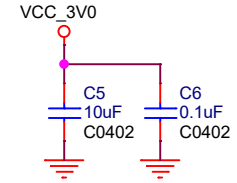
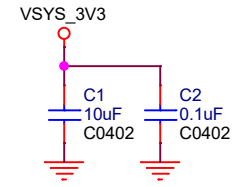
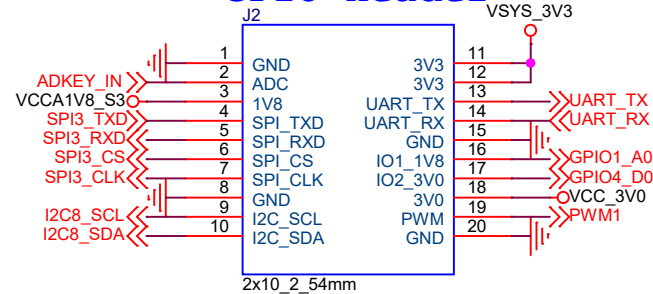
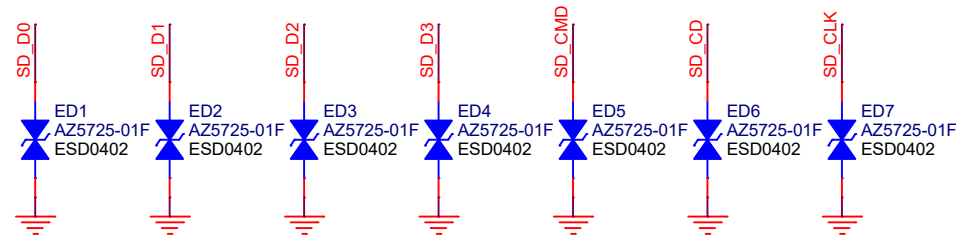
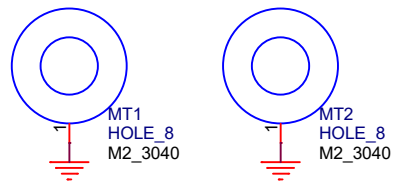

Shenzhen Wesion Technology Co., Ltd.			
<b>Project:</b>	Edge		
<b>File:</b>	Edge IO		
<b>Date:</b>	Monday, October 08, 2018	<b>Rev:</b>	V13
<b>Designed by:</b>	Gouwa	<b>Sheet:</b>	1 of 1